

ESD protection for high speed interface

Features

- Diode array topology
- Low capacitance (12 pF typical)
- Lead-free package

Benefits

- Low capacitance uni-directional ESD protection.
- Low PCB space consuming, 2.5 mm² max. footprint
- Low leakage current
- High reliability offered by monolithic integration

Complies with the following standards

- IEC 61000-4-2 level 4:
 - 8 kV (contact discharge)
 - 15 kV (air discharge)
- MIL STD 883G-Method 3015-7: class3B
 - Human body model

Applications

Where transient overvoltage protection in ESD sensitive equipment is required, such as:

- Computers
- Printers
- Communication systems
- Cellular phone handsets and accessories
- Video equipment

Description

The ESDALC6V1-5P6 is a monolithic array designed to protect up to 5 lines against ESD transients.

The device is ideal for high speed interface applications where both reduced printed circuit board space and power absorption capability are required.

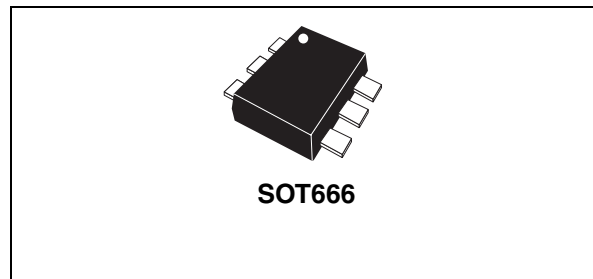
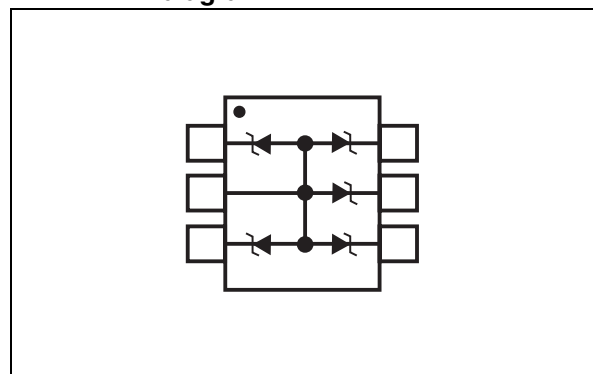

Figure 1. ESDALC6V1-5P6 functional diagram



1 Characteristics

Table 1. Absolute ratings ($T_{amb} = 25\text{ }^{\circ}\text{C}$)

Symbol	Parameter		Value	Unit
$V_{PP}^{(1)}$	Peak pulse voltage	IEC 61000-4-2 contact discharge IEC 61000-4-2 air discharge	± 8 ± 15	kV
$P_{PP}^{(1)}$	Peak pulse power dissipation (8/20 μs)	T_j initial = T_{amb}	30	W
I_{PP}	Peak pulse current (8/20 μs)		2.5	A
T_j	Junction temperature		125	$^{\circ}\text{C}$
T_{stg}	Storage temperature range		-55 to +150	$^{\circ}\text{C}$
T_L	Maximum lead temperature for soldering during 10 s		260	$^{\circ}\text{C}$
T_{OP}	Operating temperature range		- 40 + 125	$^{\circ}\text{C}$

1. For a surge greater than the maximum values, the diode will fail in short-circuit.

Table 2. Electrical characteristics ($T_{amb} = 25\text{ }^{\circ}\text{C}$)

Symbol	Parameter					
V_{RM}	Stand-off voltage					
V_{BR}	Breakdown voltage					
V_{CL}	Clamping voltage					
I_{RM}	Leakage current					
I_{PP}	Peak pulse current					
αT	Voltage temperature coefficient					
V_F	Forward voltage drop					
C	Capacitance					
R_d	Dynamic resistance					
Parameter	Test condition					
V_{RRM}	Reverse stand-off voltage				5	V
V_{BR}	$I_R = 1\text{ mA}$		6.1		7.2	V
I_{RM}	$V_{RM} = 3\text{ V}$				70	nA
V_{CL}	Non repetitive peak pulse voltage (8/20 μs)	$I_{PP} = 1\text{ A}$			10	V
		$I_{PP} = 2.5\text{ A}$			14	
V_F	$I_F = 10\text{ mA}$				1	V
R_d				2	3	Ω
$\alpha T^{(1)}$	$I_R = 1\text{ mA}$				5	$10^{-4}/^{\circ}\text{C}$
C	$V_R = 0\text{ V DC}$, $F = 1\text{ MHz}$, $V_{osc} = 30\text{ mV rms}$			12	15	pF

1. $\Delta V_{BR} = \alpha T \times (T_{amb} - 25\text{ }^{\circ}\text{C}) \times V_{BR} (25\text{ }^{\circ}\text{C})$

Figure 2. Relative variation of peak pulse power versus initial junction temperature

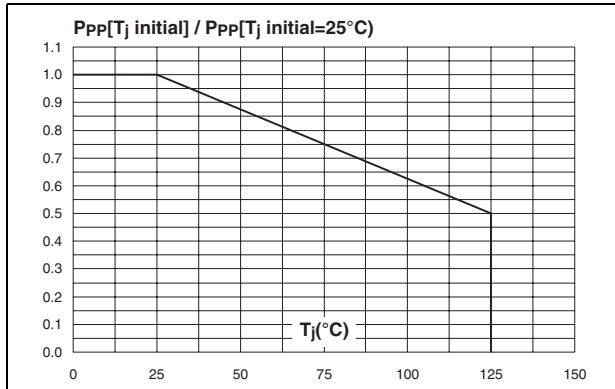

Figure 3. Peak pulse power versus exponential pulse duration (Tj initial = 25 °C)

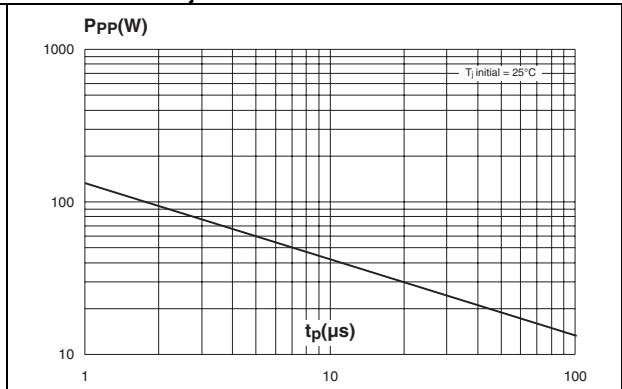

Figure 4. Clamping voltage versus peak pulse current (typical values)

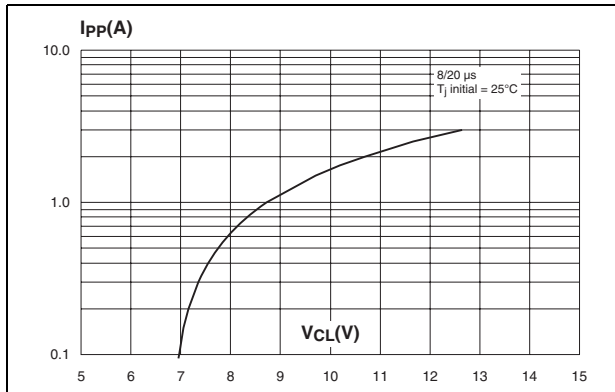

Figure 5. Relative variation of leakage current versus junction temperature (typical values)

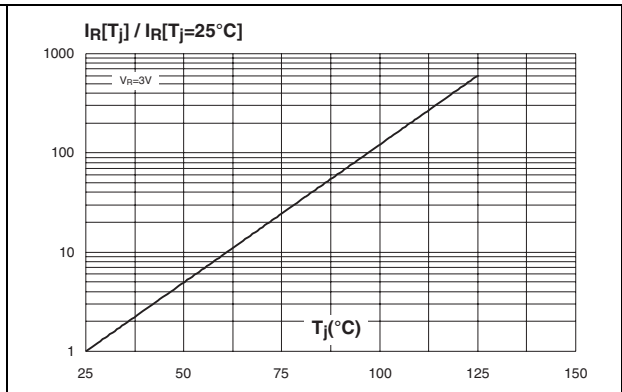

Figure 6. Breakdown voltage versus initial junction temperature

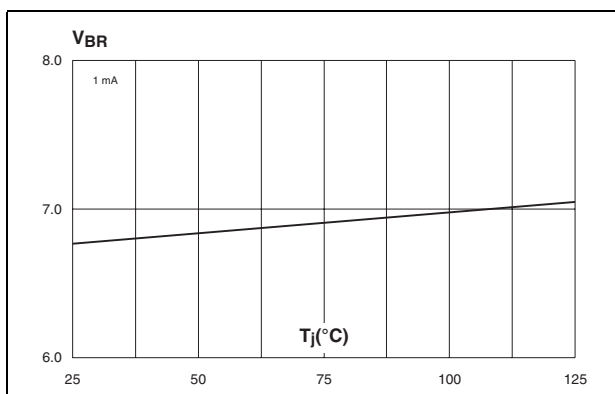

Figure 7. Junction capacitance versus reverse voltage applied (typical values)

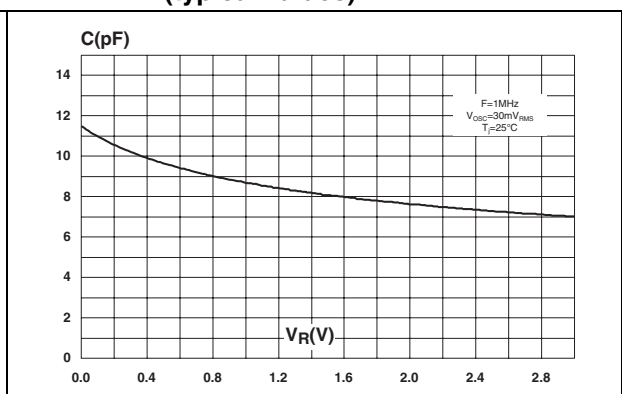

Figure 8. ESD response to IEC 61000-4-2 (air discharge +15 kV surge)

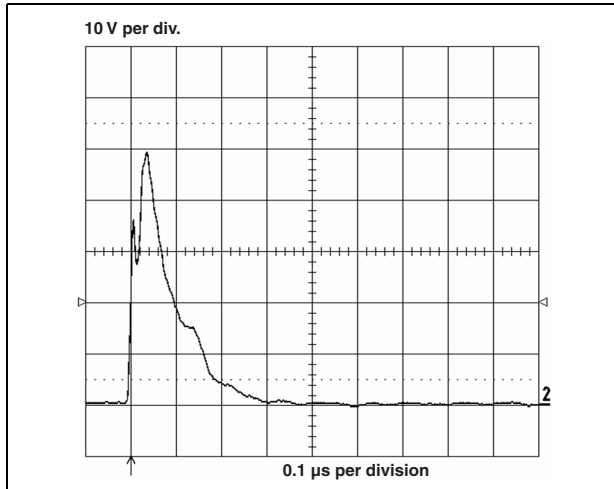

Figure 9. ESD response to IEC 61000-4-2 (air discharge -15 kV surge)

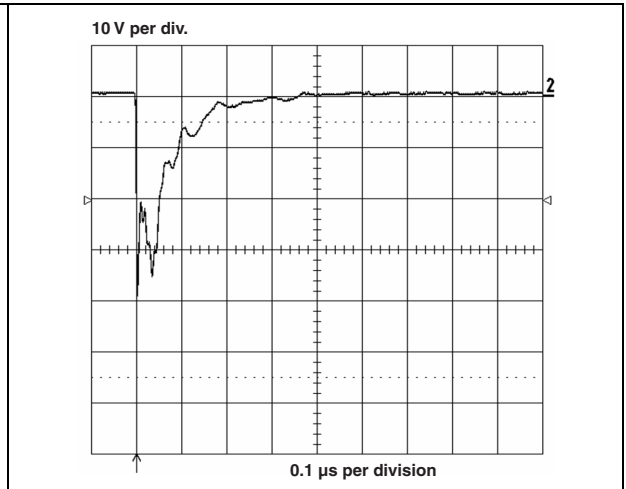

Figure 10. Frequency response curves - all lines together

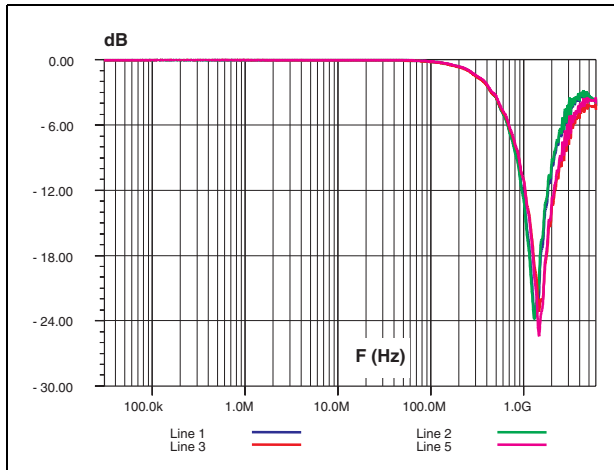
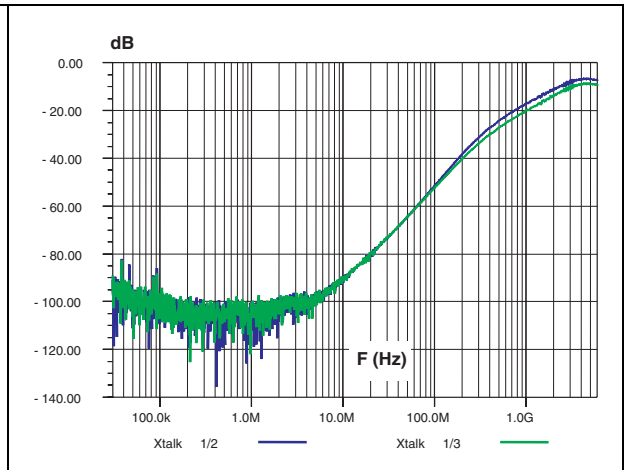
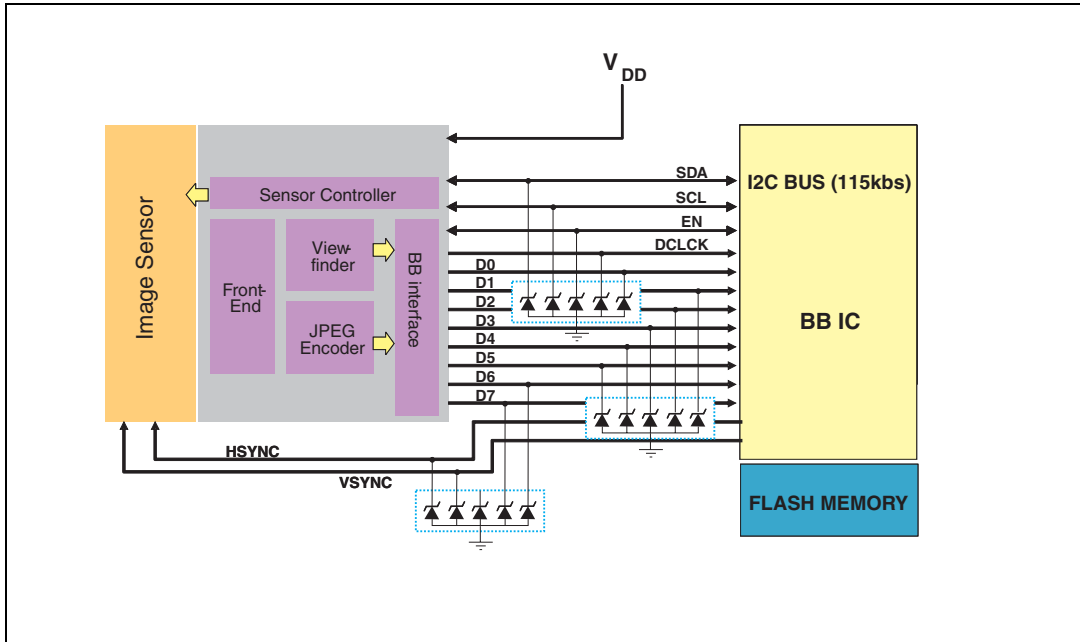

Figure 11. Crosstalk response curves - 1/2 and 1/3



2 Application information

Figure 12. Application schematic diagram



3 Ordering information scheme

Figure 13. Ordering information scheme

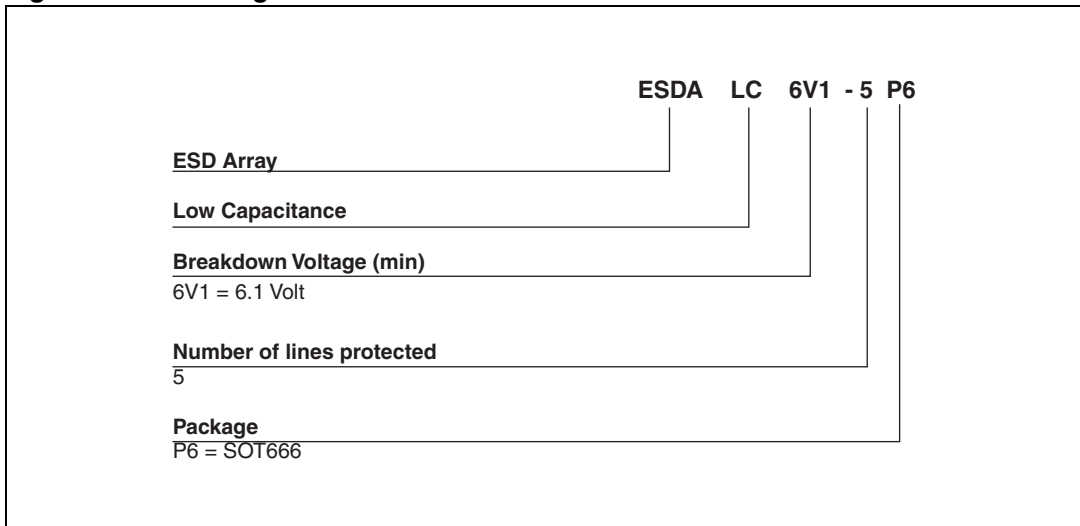

4 Package information

- Epoxy meets UL 94, V0

In order to meet environmental requirements, ST offers these devices in ECOPACK® packages. These packages have a lead-free second level interconnect. The category of second level interconnect is marked on the package and on the inner box label, in compliance with JEDEC Standard JESD97. The maximum ratings related to soldering conditions are also marked on the inner box label. ECOPACK is an ST trademark. ECOPACK specifications are available at: www.st.com.

Table 3. SOT666 dimensions

Ref.	Dimensions					
	Millimeters			Inches		
	Min.	Typ.	Max.	Min.	Typ.	Max.
A	0.45		0.60	0.018		0.024
A3	0.08		0.18	0.003		0.007
b	0.17		0.34	0.007		0.013
b1	0.19	0.27	0.34	0.007	0.011	0.013
D	1.50		1.70	0.059		0.067
E	1.50		1.70	0.059		0.067
E1	1.10		1.30	0.043		0.051
e		0.50			0.020	
L1		0.19			0.007	
L2	0.10		0.30	0.004		0.012
L3		0.10			0.004	

Figure 14. SOT666 footprint (dimensions in mm)

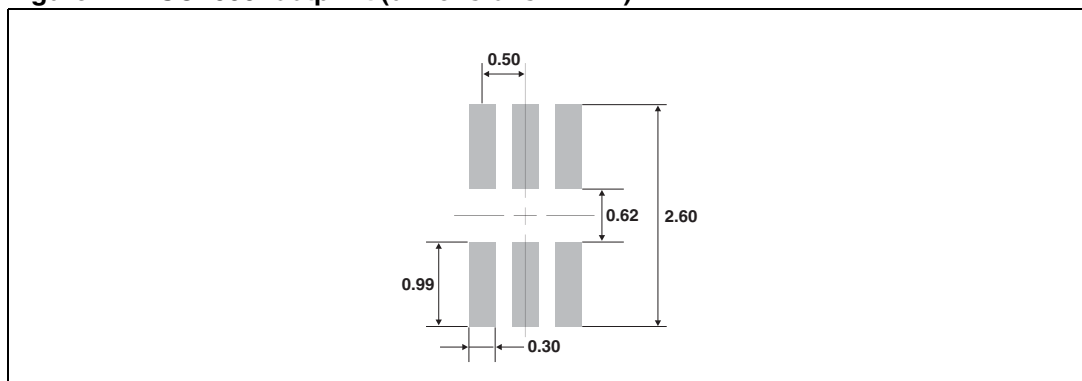
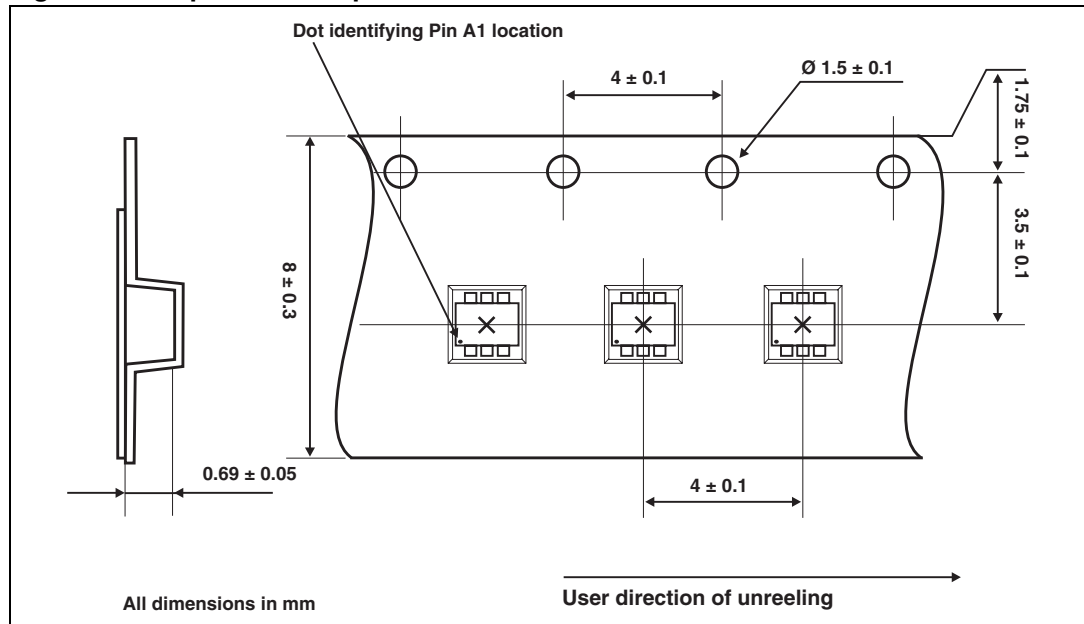

Figure 15. Tape and reel specifications



Note: Product marking may be rotated by 90° for assembly plant differentiation. In no case should this product marking be used to orient the component for its placement on a PCB. Only pin 1 mark is to be used for this purpose.

5 Ordering information

Table 4. Ordering information

Order code	Marking	Package	Weight	Base qty	Delivery mode
ESDALC6V1-5P6	J ⁽¹⁾	SOT666	2.9 mg	3000	Tape and reel

1. The marking can be rotated by 90° to differentiate assembly location

6 Revision history

Table 5. Document revision history

Date	Revision	Description of changes
29-May-2007	1	First issue.
30-Jul-2007	2	Upgrade V _{CL} from 8 V to 10 V and from 9.5 V to 14 V.
15-Nov-2007	3	Reformatted to current standards. Marking changed to J in Table 4. Notes on marking rotation added to Table 4 and Figure 15.

Please Read Carefully:

Information in this document is provided solely in connection with ST products. STMicroelectronics NV and its subsidiaries ("ST") reserve the right to make changes, corrections, modifications or improvements, to this document, and the products and services described herein at any time, without notice.

All ST products are sold pursuant to ST's terms and conditions of sale.

Purchasers are solely responsible for the choice, selection and use of the ST products and services described herein, and ST assumes no liability whatsoever relating to the choice, selection or use of the ST products and services described herein.

No license, express or implied, by estoppel or otherwise, to any intellectual property rights is granted under this document. If any part of this document refers to any third party products or services it shall not be deemed a license grant by ST for the use of such third party products or services, or any intellectual property contained therein or considered as a warranty covering the use in any manner whatsoever of such third party products or services or any intellectual property contained therein.

UNLESS OTHERWISE SET FORTH IN ST'S TERMS AND CONDITIONS OF SALE ST DISCLAIMS ANY EXPRESS OR IMPLIED WARRANTY WITH RESPECT TO THE USE AND/OR SALE OF ST PRODUCTS INCLUDING WITHOUT LIMITATION IMPLIED WARRANTIES OF MERCHANTABILITY, FITNESS FOR A PARTICULAR PURPOSE (AND THEIR EQUIVALENTS UNDER THE LAWS OF ANY JURISDICTION), OR INFRINGEMENT OF ANY PATENT, COPYRIGHT OR OTHER INTELLECTUAL PROPERTY RIGHT.

UNLESS EXPRESSLY APPROVED IN WRITING BY AN AUTHORIZED ST REPRESENTATIVE, ST PRODUCTS ARE NOT RECOMMENDED, AUTHORIZED OR WARRANTED FOR USE IN MILITARY, AIR CRAFT, SPACE, LIFE SAVING, OR LIFE SUSTAINING APPLICATIONS, NOR IN PRODUCTS OR SYSTEMS WHERE FAILURE OR MALFUNCTION MAY RESULT IN PERSONAL INJURY, DEATH, OR SEVERE PROPERTY OR ENVIRONMENTAL DAMAGE. ST PRODUCTS WHICH ARE NOT SPECIFIED AS "AUTOMOTIVE GRADE" MAY ONLY BE USED IN AUTOMOTIVE APPLICATIONS AT USER'S OWN RISK.

Resale of ST products with provisions different from the statements and/or technical features set forth in this document shall immediately void any warranty granted by ST for the ST product or service described herein and shall not create or extend in any manner whatsoever, any liability of ST.

ST and the ST logo are trademarks or registered trademarks of ST in various countries.

Information in this document supersedes and replaces all information previously supplied.

The ST logo is a registered trademark of STMicroelectronics. All other names are the property of their respective owners.

© 2007 STMicroelectronics - All rights reserved

STMicroelectronics group of companies

Australia - Belgium - Brazil - Canada - China - Czech Republic - Finland - France - Germany - Hong Kong - India - Israel - Italy - Japan - Malaysia - Malta - Morocco - Singapore - Spain - Sweden - Switzerland - United Kingdom - United States of America

www.st.com